









### Yealink Wireless DECT Conference Phone

Yealink Wireless DECT Conference Phone CP930W, based on the reliable and secure DECT technology, is designed for wireless communication environments such as small-to-medium meeting rooms and huddle rooms. The CP930W not only ensures you up to 24 call hours, but also deliver the first-rate audio quality to you with the Yealink Noise Proof technology that your conference calls will be filled with the dynamics they deserve. In addition, the wireless design entirely frees you from the network and power outlets troubles and makes your conference table more uncluttered than ever before.

Another smart feature is that Yealink CP930W provides wireless and wired pairing with your mobile staff - smartphone or PC/tablet via Bluetooth and USB Micro-B port to merge all these three devices, your smartphone, PC/tablet and CP930W into one hybrid UC meeting. Making your conference calls be mobile and flexible via Yealink CP930W which abandons the limitation of conference rooms and holds meetings anywhere you want within DECT coverage.

			
Built-in Battery	DECT Technology	5-way Conference Call	HD Audio
			
Pairing via USB	Pairing via Bluetooth	Call Recording	Hybrid UC meeting



#### Key Features and Benefits

##### Complete Freedom

Employing DECT technology, the Yealink CP930W Wireless DECT Conference Phone allows you to hold meetings wherever or whenever is convenient for you, entirely free you from the network and power outlets troubles. Also, its built-in rechargeable battery ensures up to 24 hours of call time and 15 days of standby time, guaranteeing a long working time without recharging and making CP930W totally wireless in DECT environment.

##### Superior Audio Quality

The Yealink CP930W DECT conference phone, marrying the Yealink Noise Proof Technology, unburdens the business conversation by reducing annoying noise and minimizing distractions to set audio experience into a new level. Thanks to its built-in 3-microphone array, CP930W owns a 20-foot (6-meter) and 360-degree voice pickup range as if all participants are sitting across the table from each other!

##### Sensitive Touch, Elegant Control

This Y-shape phone released from Yealink, representing the first letter Y of Yealink, owns a sensitive touch keypad which perfectly cancels the keypad noise and facilitates your conference room experience by simply putting all of the key conferencing functions at your fingertips.

##### Hybrid UC Meeting

With Yealink CP930W, up to five parties can join a conference call from different locations, helping your company cut costs and save time. Pairing Yealink CP930W with your smartphone (via Bluetooth) or PC/tablet (via micro USB) allows you to turn the Yealink CP930W into a loudspeaker and microphone with ease. In addition, you can merge your smartphone, PC/tablet and SIP call into one hybrid UC meeting.

- 3.1" 248x120-pixel graphical LCD with backlight
- Built-in rechargeable Lithium battery
- Up to 24-hour talk time
- Up to 15-day standby time
- 3.75-hour charging time
- Built-in 3-microphone array
- Optima HD voice, full duplex technology
- 20-foot (6-meter) and 360-degree microphone pickup range
- Yealink Noise Proof technology
- 5-way conference call
- Connect to PC via Micro USB port
- Connect to mobile phone via Bluetooth
- Hybrid UC meeting
- Call recording via Micro SD card
- Sensitive touch keypad
- Upgrade Over-the-Air (OTA)
- Work with Yealink W60B Base Station

### Display

- 3.1" 248x120-pixel graphical LCD with backlight
- Sensitive touch keypad
- 25 total keys:
  - 4 soft keys, off-hook key, on-hook key, 12-key numerical keypad, Bluetooth, mute, volume keys,
  - 2 navigation keys, OK key
- Multilingual user interface
- Caller ID with name and number

### Audio features

- Optimal HD audio
- Yealink Noise Proof Technology
- Background noise suppression
- 20-foot (6-meter) microphone pickup range
- Apply to small to medium conference room
- Built-in 3-microphone array, 360-degree voice pickup
- 56mm diameter and 5w speaker
- Full-duplex speakerphone with AEC
- Echo cancellation tail length is up to 240ms
- Wideband codec: Opus, AMR-WB (optional), G.722
- Narrowband codec: PCMU, PCMA, G.726, G.729, iLBC
- Receiver volume control: 15 steps
- Ringer volume control: 15 steps
- 10 ringer melodies
- Multiple advisory tones
- Acoustic warning for low battery status
- DTMF
- VAD, CNG, PLC, AJB, AGC

### Phone features

- 5-way conference call
- 100 phone book memory (store in the base)
- Remote phonebook
- Phonebook search, black list
- Call history (All/Missed/Placed/Received)
- Call transfer, dial plan
- Paging, intercom
- Call hold, call waiting, mute, DND, call recording

- Call forward (always/busy/no answer)
- Emergency call
- Anonymous call
- Anonymous call rejection
- Set date time manually or automatically
- Pairing with mobile phone via Bluetooth
- Pairing with PC via micro USB
- Direct IP call without SIP proxy
- Reset to factory, reboot
- Phone upgrade: OTA (Over-The-Air)

### Interface

- Built-in Bluetooth 4.0
- 1 x micro USB port
- 1 x micro SD slot
- 1 x Security slot

### DECT

- Frequency bands:
  - 1880 - 1900 MHz (Europe),
  - 1920 - 1930 MHz (US)
- DECT standards: CAT-iq2.0

### Physical features

- Color: Space Silver
- DECT Range:
  - Up to 50 meters indoor (in ideal conditions)
  - Up to 300 meters outdoor (in ideal conditions)
- Built-in rechargeable Lithium battery
- 24 hours talk time (in ideal conditions)
- 360 hours standby time (in ideal conditions)
- External Yealink power adapter:
  - AC 100~240V input and DC 12V/1A output
- Dimension (W\*D\*H):
  - Phone: 307.8mm\*298.5mm\*66.9mm
  - Charging cradle: 110mm\*127mm\*21.5mm
- Operating humidity: 10~90%
- Storage temperature: -10~40°C (+14~104°F)

### Package features

- Package content:
  - Yealink CP930W DECT conference phone
  - Charger cradle
  - Quick Start Guide
  - Yealink Power Adapter
- Qty/CTN: 5 PCS
- N.W/CTN: 8.3 kg
- G.W/CTN: 9.3 kg
- Giftbox size: 336mm\*364mm\*112mm
- Carton Meas: 587mm\*376mm\*350mm

### Compliance

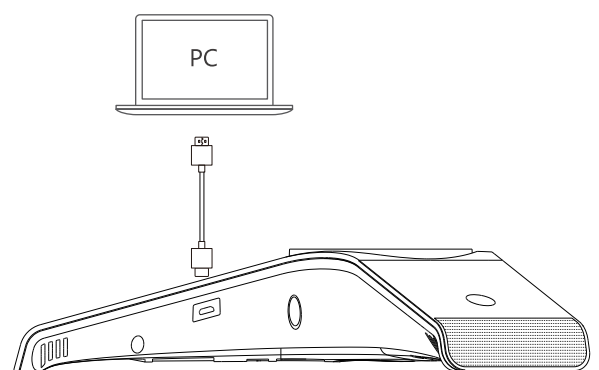
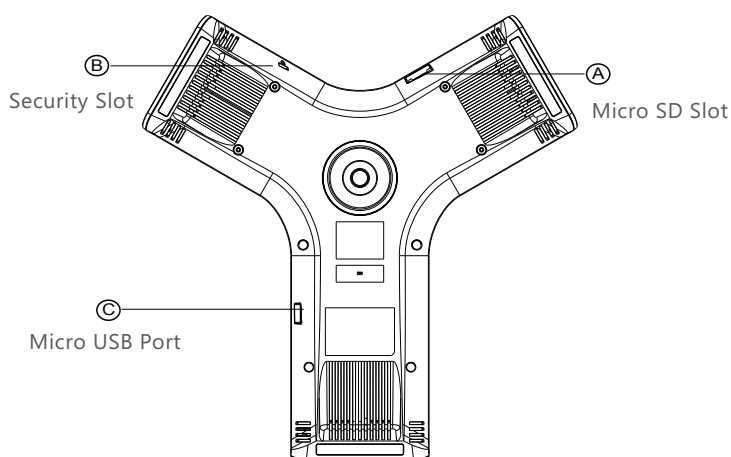



## About Yealink

Yealink is a global leading provider of enterprise communication and collaboration solutions, offering video conferencing service to worldwide enterprises. Focusing on research and development, Yealink also insists on innovation and creation. With the outstanding technical patents of cloud computing, audio, video and image processing technology, Yealink has built up a panoramic collaboration solution of audio and video conferencing by merging its cloud services with a series of endpoints products. As one of the best providers in more than 140 countries and regions including the US, the UK and Australia, Yealink ranks No.1 in the global market share of SIP phone shipments.

## Copyright

Copyright © 2018 YEALINK(XIAMEN) NETWORK TECHNOLOGY CO., LTD.

Copyright © 2018 Yealink(Xiamen) Network Technology CO., LTD. All rights reserved. No parts of this publication may be reproduced or transmitted in any form or by any means, electronic or mechanical, photocopying, recording, or otherwise, for any purpose, without the express written permission of Yealink(Xiamen) Network Technology CO., LTD.

## Technical Support

Visit Yealink WIKI (<http://support.yealink.com/>) for firmware downloads, product documents, FAQ, and more. For better service, we sincerely recommend you to use Yealink Ticketing system (<https://ticket.yealink.com>) to submit all your technical issues.



YEALINK(XIAMEN) NETWORK TECHNOLOGY CO.,LTD.  
Web: [www.yealink.com](http://www.yealink.com)  
Addr: No.1 Ling-Xia North Road, High Tech Park,  
Huli District, Xiamen, Fujian, P.R. China  
Copyright©2018Yealink Inc. All right reserved.